

3D imaging



Passion to innovate

An introduction from our President

Fantastic five.....	4
Unique 3D combination – an industry first	6
CBCT	8
3D face photo	10
3D model scanning.....	12
Planmeca ProMax® 3D family Key features	14
Ease of operation	16
Advanced technology.....	18
Pioneering low dose 3D imaging	20
2D and 3D imaging with one sensor	22
Extraoral bitewings.....	24
Quality cephalometry for orthodontics.....	26
Planmeca Romexis® – one software for all your needs.....	28
Reinventing 3D imaging	30
Implant planning made easy	32
3D tools for orthodontists and dental labs.....	34
Your mobile world of imaging.....	36
Share images and expertise online.....	38
Professionals proudly present the Planmeca ProMax® 3D family	40
Planmeca ProMax® 3D s	42
Planmeca ProMax® 3D Classic.....	44
Planmeca ProMax® 3D Plus.....	46
Planmeca ProMax® 3D Mid	48
Planmeca ProMax® 3D Max	50
Clinical images.....	52
Patient specific implants	54
Stand out with colour	56
Technical specifications	56



“Welcome to the future of digital imaging. It gives me great pleasure to introduce you to our world-leading **Planmeca ProMax® 3D** X-ray units and **Planmeca Romexis®** imaging software – with a pioneering combination of 3D images that takes you closer for an even greater understanding of what your patients need.

I’m extremely proud of our product innovations, and for over 40 years we’ve worked closely with dental professionals to set new standards in our field. What makes us a bit different is that all core product development and manufacturing takes place in Finland – ensuring exceptional quality and unmatched attention to detail at every stage of the process.

This brings us to our **Planmeca ProMax®** product family, taking care of all your 2D and 3D imaging needs in a single unit. Each product is a true all-in-one unit, offering easy-to-use controls and incredible patient comfort. We have a dedicated team of in-house R&D professionals behind the scenes, all determined to make the best possible products for you and your patients. Therefore I am thrilled to invite you to discover our complete selection of advanced 3D solutions.”

*Heikki Kyösti
President and founder
Planmeca Group*

Fantastic five

Meet the Planmeca ProMax® 3D family

Mac OS
and Windows
compatible



Planmeca ProMax® 3D s



Planmeca ProMax® 3D Classic



Planmeca ProMax® 3D Plus



Planmeca ProMax® 3D Mid



Planmeca ProMax® 3D Max

*Planmeca ProMax® 3D is a product family consisting of exceptional all-in-one units. With three different types of three-dimensional imaging – as well as panoramic, extraoral bitewing and cephalometric imaging – **these intelligent products can meet all your maxillofacial imaging needs.***

True all-in-one units for all your imaging needs.

Unique 3D combination – an industry first



*We're the first company to combine three different types of 3D data with one X-ray unit. The **Planmeca ProMax® 3D** family brings together a Cone Beam Computed Tomography (CBCT) image, 3D face photo and 3D model scan into one 3D image – using the same advanced software. This 3D combination creates a virtual patient in 3D, helping you with all your clinical needs.*



CBCT

Why Cone Beam Computed Tomography?

Cone Beam Computed Tomography (CBCT) is an X-ray imaging technology where a large number of 2D images are taken of a patient from different angles. A 3D volumetric image is then calculated from these 2D projections. The resulting images can be viewed with our advanced imaging software from any angle, including the axial, coronal, sagittal and cross-sectional planes.

See more than ever before

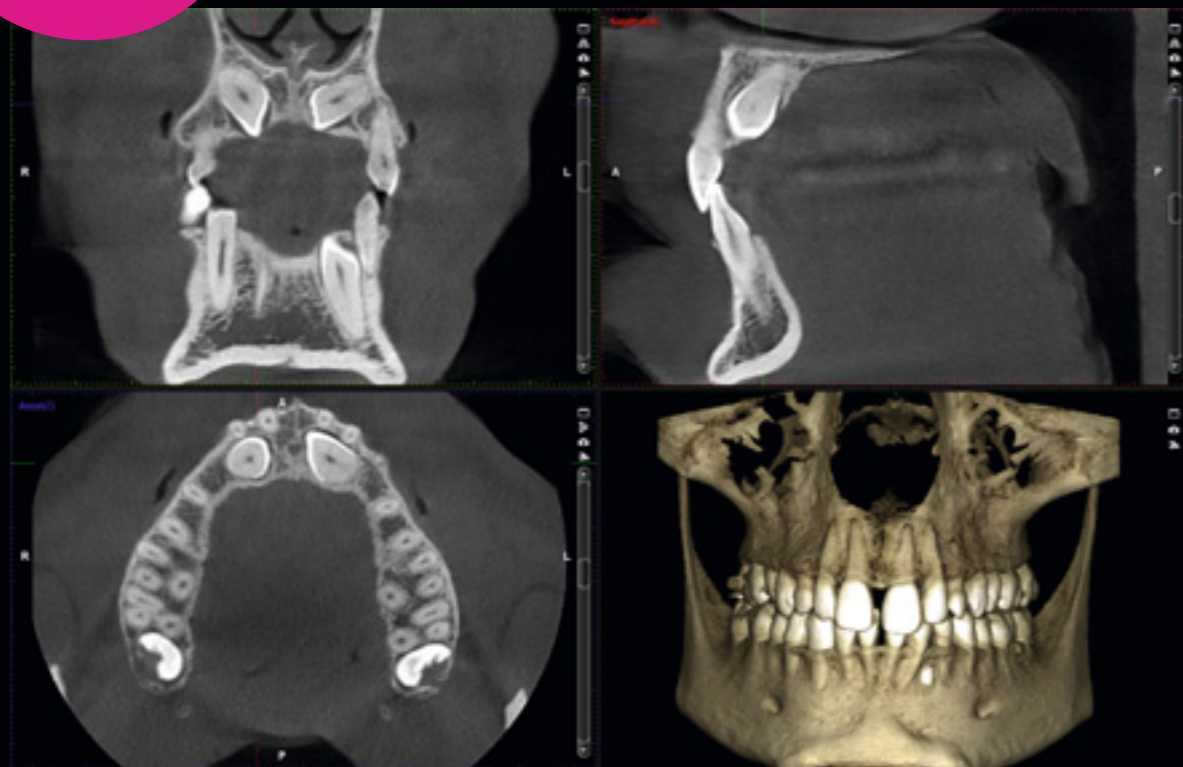

Renowned dental implant surgeon Franck Renouard couldn't imagine working without his CBCT

"I acquired my **Planmeca ProMax® 3D Classic** in 2007 and was one of the very first users in France. The choice was quickly made, as Planmeca's unit was far ahead of its competitors."

All necessary diagnostic information from a single unit

"In implant cases, I usually start the analysis by taking a panoramic radiograph or a simple intraoral radiograph. As soon as I discover an ambiguity or low volume, I go for CBCT. For some indications, such as sinus lifts or onlay bone graftings, I always use CBCT.

I usually take large-volume studies right away. This enables diagnosis of endodontic or bone lesions that could otherwise go undetected in sites other than the implant site. The unit's resolution is more than sufficient for everyday examinations. In cases where a patient has a lot of metal restorations in their mouth or a problem with staying still, the artefact filter is very useful."

Full sinus visualisation

"I take a CBCT study systematically before a sinus lift. It provides visualisation of the sinus anatomy and allows me to see if there is an intrasinus pathology or anatomical features such as septa. It also allows detecting possible thick antral arteries, which are common in the bone wall. I need to be aware of these parameters before surgery.

Nowadays, I do not like to receive paper-based exams, as radiologists often do not provide the axial views which are essential in sinus study. When I take the radiographs myself, I can choose the slice that interests me."

Improved patient satisfaction

I then use CBCT to check the integration of my graft when I fill the tissue before implant placement. I also need CBCT when there are complications, which occur in 3-5% of cases. I can assure you that the patients are delighted to receive their diagnosis and treatment immediately, with no need to visit a specialist radiology centre.

Planmeca ProMax 3D Classic is a well-designed radiology unit. All in all, using 3D has become natural to me. I only wonder how we managed before 3D!"

Dr Franck Renouard, DDS, Paris, France



Dr Renouard specifies that he has not received any financial compensation or other benefit for this interview.

Unique 3D combination

3D face photo

Planmeca ProFace® is an exclusive 3D face photo system available for all of our 3D X-ray units. This pioneering integrated system produces a realistic 3D face photo and CBCT image in a single imaging session. You can also take a separate 3D face photo without exposing your patient to any radiation.

The world's first X-ray integrated face camera

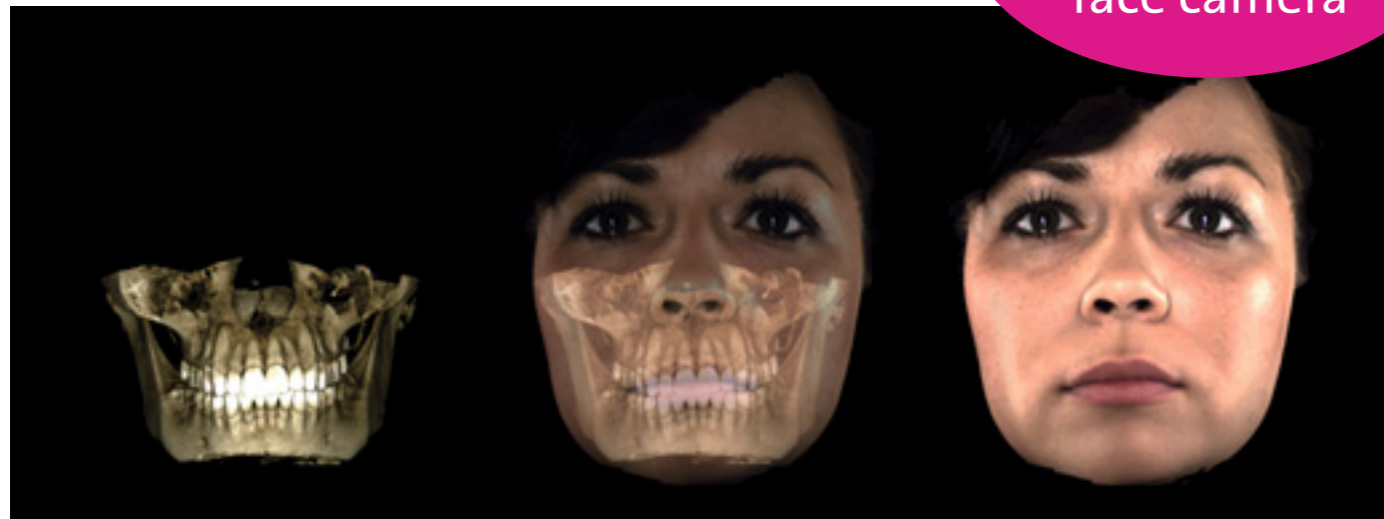

Planmeca ProFace® – the face in 3D

Designed to fulfil the most diverse diagnostic needs of today's maxillofacial and dental professionals, **Planmeca ProFace®** is a highly effective tool for pre-operative planning and treatment follow-up. It's also ideal for patient motivation and for sharing information with colleagues.

Safer and faster facial surgery

The 3D photo visualises soft tissue in relation to dentine and facial bones. As both a CBCT image and a 3D photo are generated in one imaging session, the patient position, facial expression, and muscle position remain unchanged – resulting in images that are perfectly compatible.

Careful pre-operative planning – where you can study the facial anatomy thoroughly using our **Planmeca Romexis®** software – facilitates accurate and detailed operations and enhances the aesthetic result.

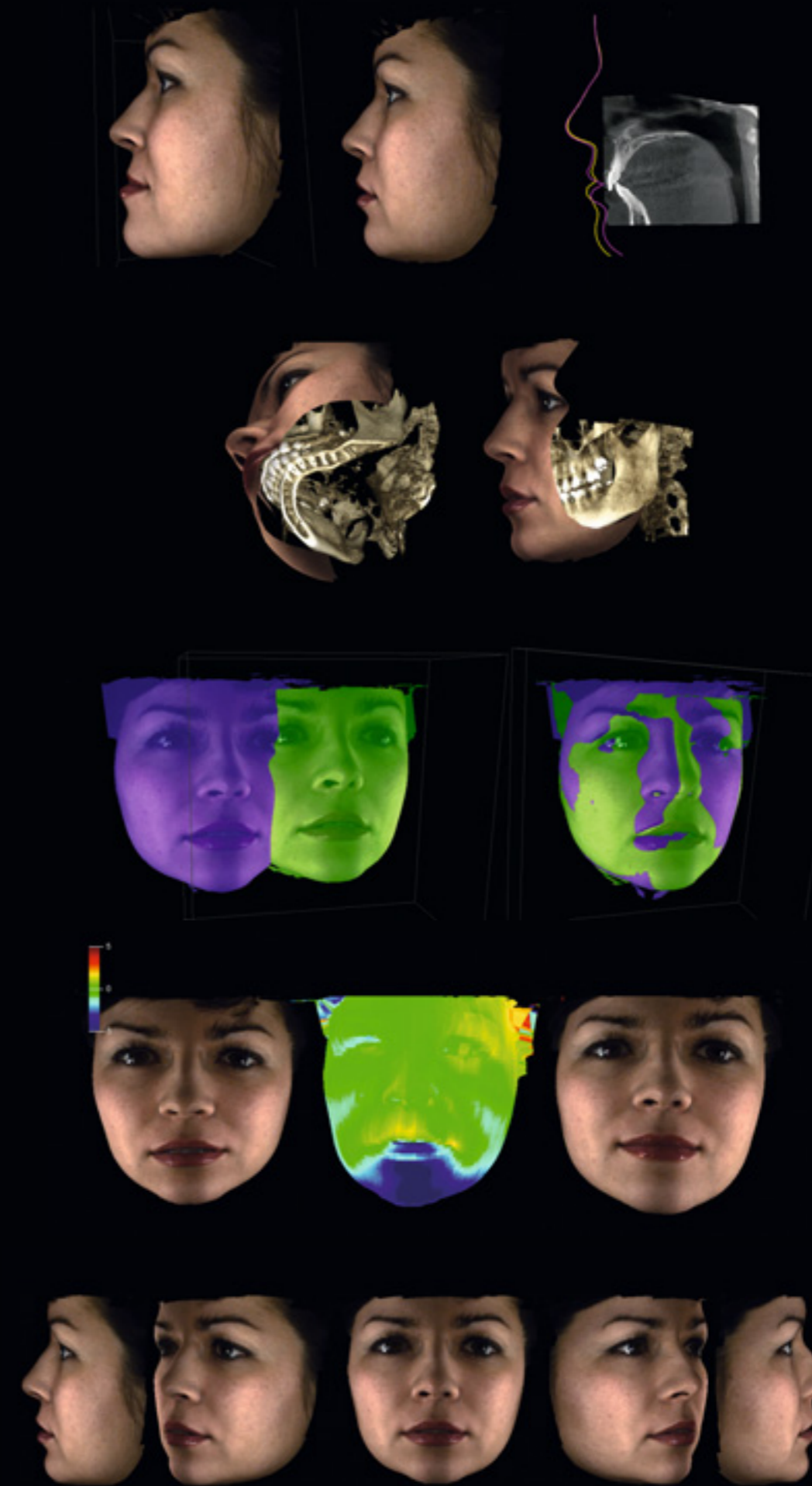

Pre and post-operative comparisons

Measure distances and relationships between bone and soft tissue

Superimpose images for comparison

Shows deviation to instantly see any changes

Create a 2D photo series automatically

Unique 3D combination

3D model scanning

You can use all X-ray units in the **Planmeca ProMax® 3D** family to scan both impressions and plaster casts – an exciting feature that was an industry first for our CBCT units. And with our advanced **Planmeca Romexis®** software, the digitised models are available immediately and stored for later use.



Scanning a plaster cast to a digital model



Scanning an impression to a digital model

Advantages of 3D model scanning

Digital models save space

3D digital models are stored in the **Planmeca Romexis®** database in standard STL format, which reduces the need to make or maintain physical plaster casts.

Create your virtual patient

The scanned 3D model can be superimposed on to CBCT data, creating a virtual patient and helping you with all your clinical and treatment planning needs. The combined data set provides an artefact-free model of your patient's dentition including bone, crowns and soft tissue. This offers valuable new options for implant planning, surgical guide manufacturing, orthodontic purposes and orthognathic surgery.

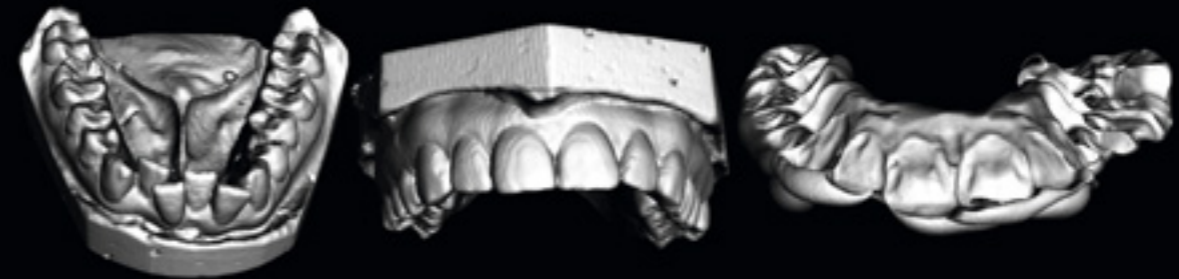

Scanned impressions of upper and lower arches and bite index in 3D

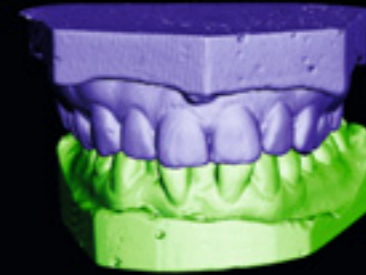

Upper and lower arch models in occlusion. A useful tool for orthodontic treatment planning and patient progress follow-up

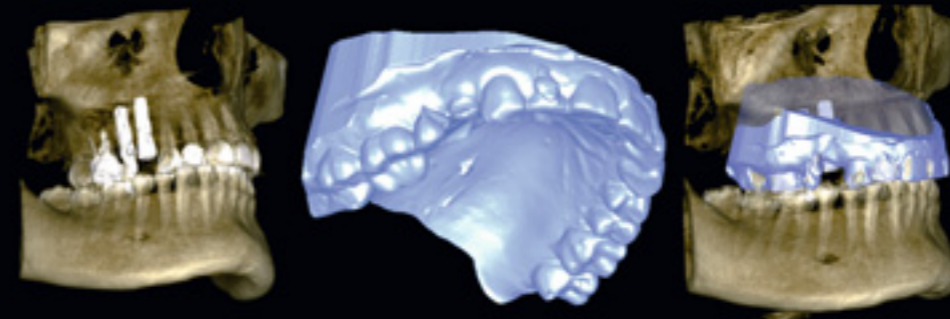

Superimposed CBCT and 3D model of upper jaw. Measure, compare, and track changes in teeth movements



Crown, impression scan, and CBCT for more accurate implant planning



Analyse the STL data further in the Planmeca Romexis® 3D Ortho Studio module, and then carry out a comprehensive dental cast analysis and create an orthodontic treatment plan

Planmeca ProMax® 3D family Key features

Advanced technology:

- Ideal resolutions and optimal balance between image quality and patient dose – always complying with the ALARA (*As Low As Reasonably Achievable*) principle
- The pioneering **Planmeca Ultra Low Dose™** protocol enables CBCT imaging with an even lower dose than traditional 2D panoramic imaging
- Optimal volume size and location for every clinical need
- Special imaging protocols for dental and ENT applications

Effortless use:

- Effortless patient positioning and unmatched comfort
- True all-in-one X-ray units not only for 3D imaging, but 2D panoramic and cephalometric imaging* as well
- Easy to use for a smooth workflow
- **Planmeca Romexis®** software
- Mac OS and Windows support



* All 2D modalities not available in Planmeca ProMax® 3D Max

Ease of operation

Our **Planmeca ProMax® 3D** units are known across the world for incredible ease of use and exceptional patient comfort. A relaxed patient means a smooth imaging workflow and the best quality images.

Unmatched patient support

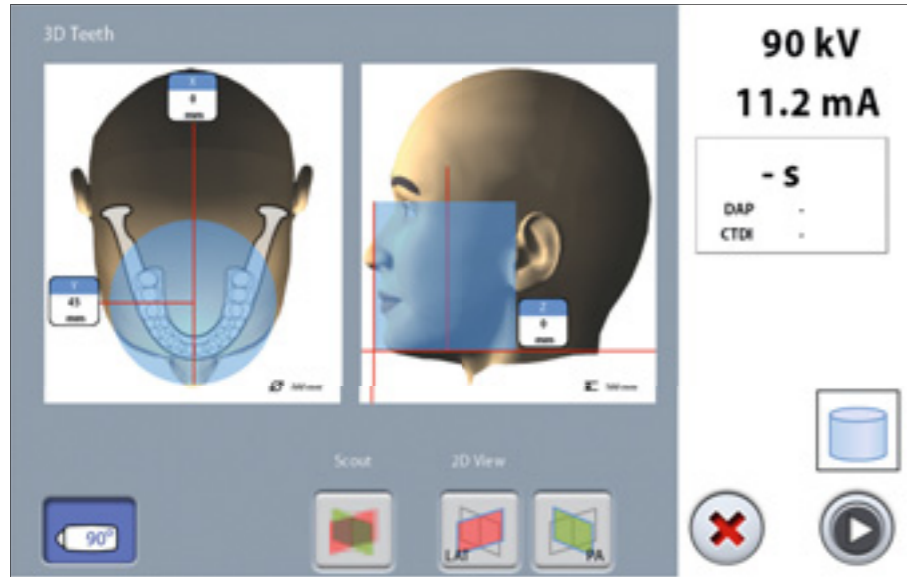

Open patient positioning

- Effortless positioning with open-face architecture
- Unrestricted view of your patient
- No claustrophobic feeling for your patient
- Fine adjustment using positioning lasers and joystick
- Verify correct positioning with a scout image
- Easy wheelchair accomodation with side-entry access

User-friendly Planmeca ProTouch™ control panel

- Clear and straightforward graphical user interface guides you smoothly through the work process
- Pre-programmed sites and exposure values for different image types and targets save you time and allow you to focus on your patients

Easy imaging with ready-designed protocols

- Imaging protocols designed for specific diagnostic tasks, areas, or target sizes
- Appropriate volume size, resolution, and exposure values
- Automatic selection and adjustment of the target position
- Reduced volume sizes for child patients to prevent unnecessary radiation

Scout images for easy positioning

Scout images and 2D views help positioning and can even be used for preliminary diagnosis.

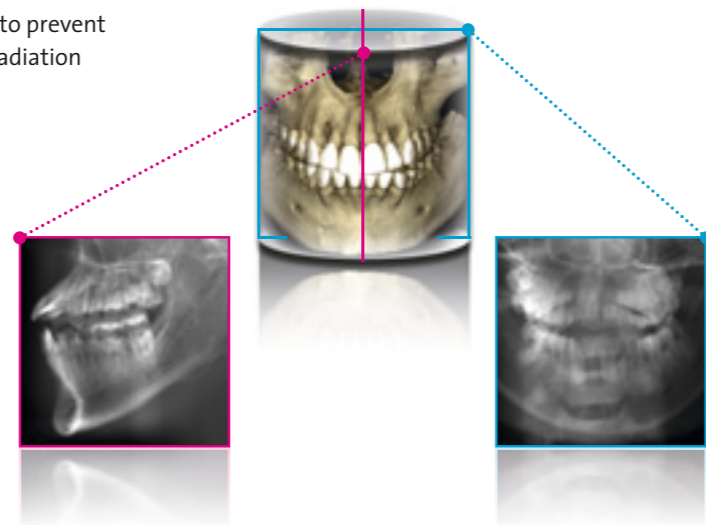

Advanced technology

Our intelligent high-tech solutions and algorithms guarantee an ideal imaging geometry, perfect usability, and crystal-clear images free from noise and artefacts.



Intelligent solutions for the best image quality

SCARA technology

The precise, free-flowing, computer-controlled SCARA (*Selectively Compliant Articulated Robot Arm*) arm construction can produce any movement pattern required. This enables accurate and reliable volume positioning and volume diameter adjustment, reducing the amount of radiation your patients are exposed to.

Optimized imaging modes for different needs

- **Low dose** mode takes the image with a minimal dose of radiation. Ideally suited for orthodontic, pediatric and sinus studies. Voxel size 400 or 600 μm
- **Normal** mode is the best choice for most common imaging needs. Voxel size 200 μm
- **High definition** mode is designed for imaging of small objects, such as ear bones. Voxel size 150 μm
- **High resolution** gives more detail, when necessary. Voxel size 100 μm
- **Endodontic** mode offers the best resolution with the smallest size. Voxel size 75 μm

ROI for higher resolution images

The ROI (Region of Interest) reconstruction function can generate a new small voxel volume from the image data of a previously taken large voxel volume. This enables a more precise diagnosis without the need for an additional radiation dose for the patient.

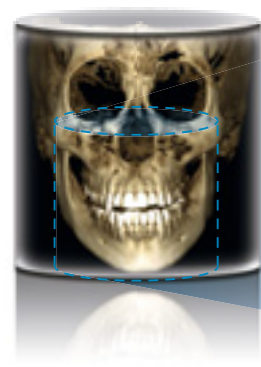

Original volume, 400 μm



Reconstructed volume with higher resolution, 200 μm

New endodontic mode

The endodontic imaging mode provides perfect visualisation of even the finest anatomical details. This advanced imaging mode is an ideal choice for endodontics and other cases with small details.

- Extremely high resolution with 75 μm voxel size
- Enables precise diagnostics and treatment planning

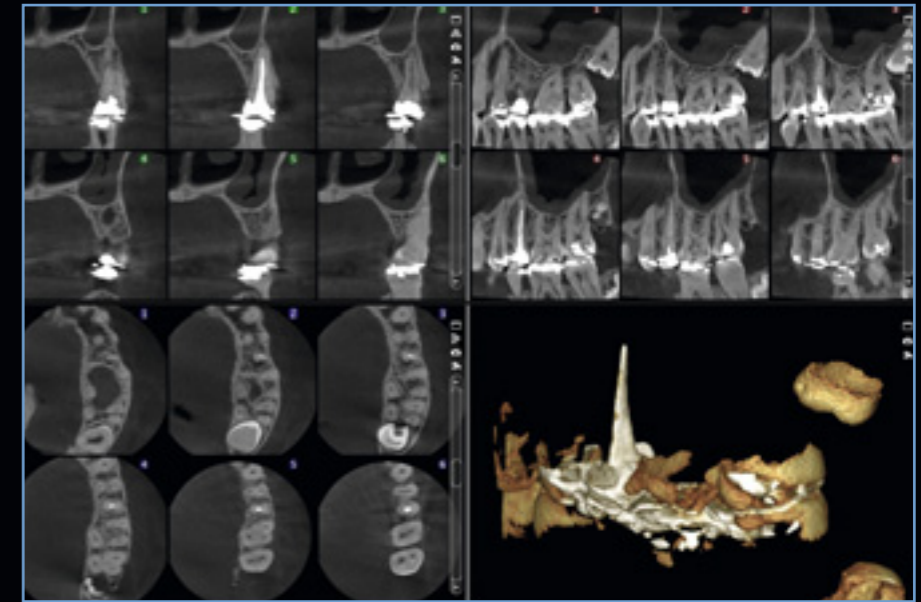

Noise-free images with Planmeca AINO™

Planmeca AINO™ is an intelligent 3D noise filter that removes noise from CBCT images without losing valuable details. The filter is useful in the **Planmeca Ultra Low Dose™** protocol, where noise is induced by the particularly low dose. It also improves image quality in the endodontic imaging mode, where noise is inherent due to an extremely small voxel size. Planmeca AINO also allows reducing exposure values in all other imaging modes by reducing noise.

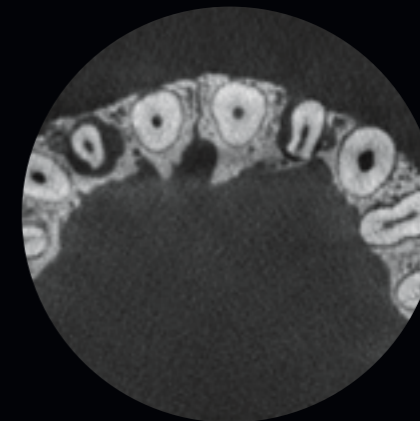

Without noise removal

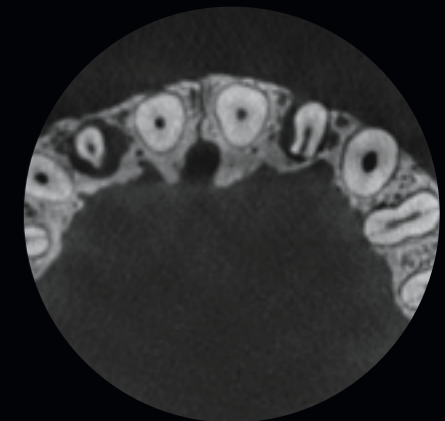

With Planmeca AINO™ noise filter

Planmeca ARA™ – enjoy your 3D images without artefacts

Metal restorations and root fillings in the patient's mouth can cause shadows and streaks in CBCT images. The intelligent **Planmeca ARA™** system removes these artefacts efficiently from **Planmeca ProMax® 3D** images. Our pioneering algorithm is based on a heuristic model and is the result of extensive scientific research and a vast amount of clinical patient data.

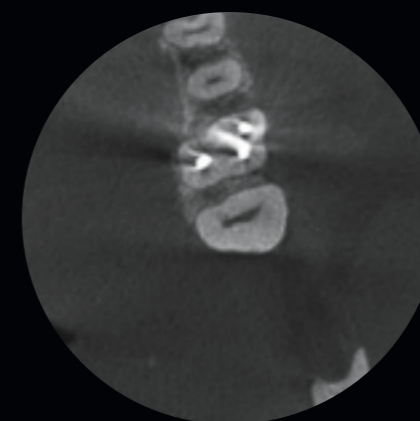

Without artefact removal



With Planmeca ARA™ artefact removal algorithm

Pioneering low dose 3D imaging

Planmeca ProMax® 3D units offer a unique Planmeca Ultra Low Dose™ imaging protocol that enables CBCT imaging with an even lower patient radiation dose than standard 2D panoramic imaging.



More information, less radiation

Planmeca Ultra Low Dose™ can be used with all voxel sizes and in all imaging modes from Normal to Endodontic mode. Using the Planmeca Ultra Low Dose protocol reduces the effective patient dose by up to 75–80%.

The unique and pioneering imaging protocol is based on intelligent 3D algorithms developed by Planmeca. Our 3D imaging system always allows the clinician to choose the optimal balance between image quality and dose, based on the ALARA principle.

Ideal for many clinical cases

The Planmeca Ultra Low Dose protocol has proven to be ideal for many clinical cases.

- Orthodontics:
 - Defining the amount of bone around the root
 - Localising unerupted and impacted teeth before orthodontic treatment
 - Defining orthodontic landmarks for cephalometric analysis
- Post-operative and follow-up images in maxillofacial surgery
- Airway studies
- Sinus studies
- Implant planning

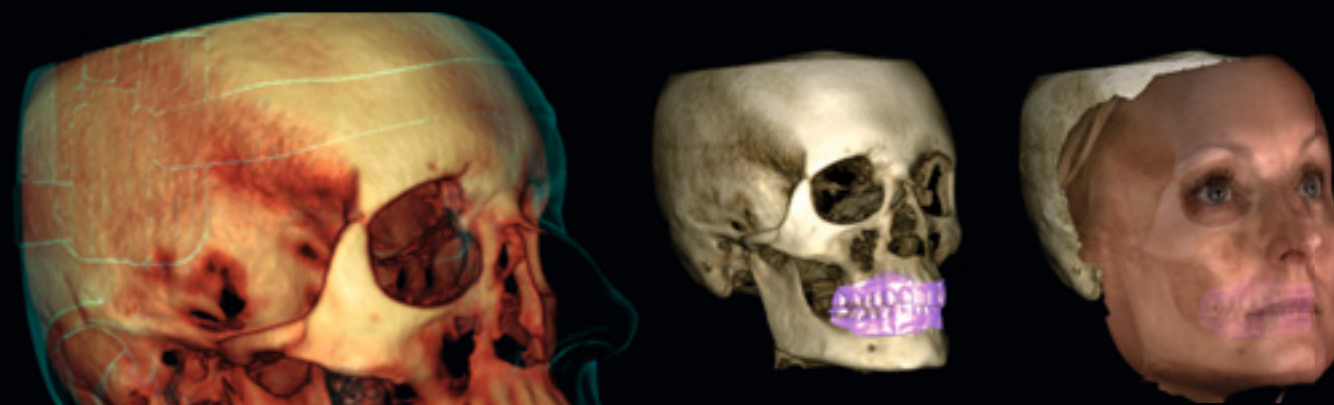
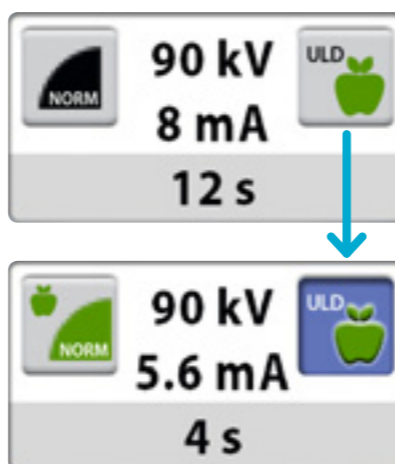

Planmeca ProMax® 3D Mid

- FOV Ø 200 x 170 mm / Voxel size 600 µm
- Effective patient dose 14.7 µSv

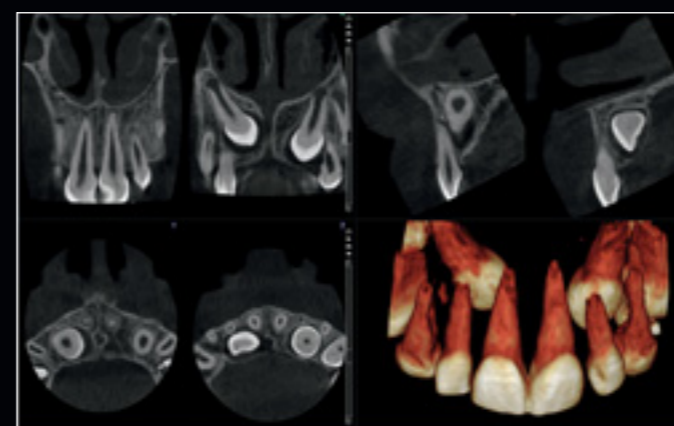

Planmeca ProMax® 3D Classic

- FOV Ø 40 x 50 mm / Voxel size 150 µm
- Effective patient dose 14.4 µSv

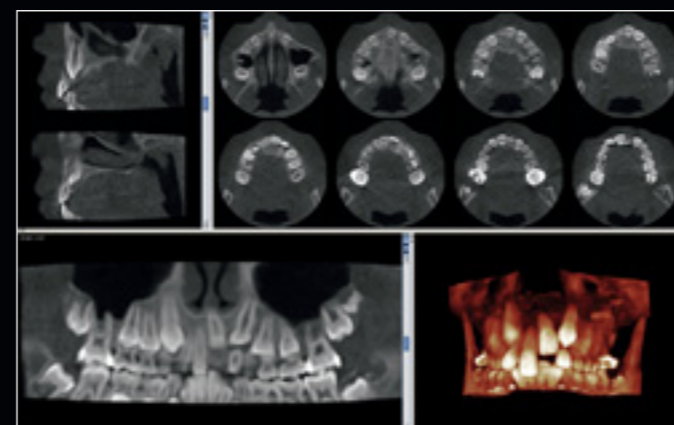

Planmeca ProMax® 3D Max

- FOV Ø 85 x 50 mm / Voxel size 400 µm
- Effective patient dose 4.0 µSv

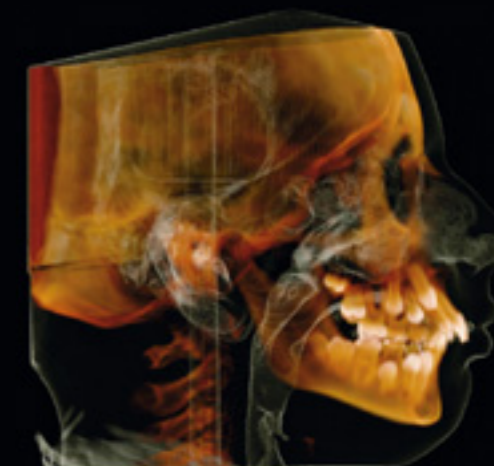

Planmeca ProMax® 3D Mid

- FOV Ø 200 x 170 mm / Voxel size 600 µm
- Effective patient dose 29.2 µSv

Planmeca Ultra Low Dose™ protocol has changed imaging practices at Tampere University Hospital



“We have been using the new **Planmeca Ultra Low Dose™** protocol since summer 2013, and have found it to be very useful in many imaging indications. These include postoperative follow-up, orthodontic cases requiring localisation of impacted teeth and their effects on adjacent teeth, detection of facial asymmetries, sinus imaging in certain ENT cases where sinusitis needs to be excluded, pharyngeal airway measurements in sleep apnea patients, as well as many implant cases.

The new imaging protocol has already changed traditional imaging practices: in many cases, 2D imaging can no longer be justified, since an ultra low dose 3D image simply gives so much additional information at a similar radiation dose.

Our patients are often concerned about radiation exposure, but once they hear that the dose is even lower than in traditional panoramic 2D imaging, they are always really relieved. Also, referring physicians often specifically ask us to use the Ultra Low Dose protocol.

We take around 2,000 CBCT images per year, and the number is constantly growing. We have been using the new protocol for the imaging of both larger and smaller areas. It has proven to be a very beneficial method improving the quality of patient care and giving a vast amount of detailed anatomical information at a low radiation dose.”

*Dr Jorma Järnstedt, DDS,
Specialist in Oral and Maxillofacial Radiology,
Tampere University Hospital,
Department of Radiology*

Dr Järnstedt specifies that he has not received any financial compensation or other benefit for this interview.

2D and 3D imaging with one sensor

Our advanced **SmartPan™** imaging system uses the same 3D sensor also for 2D panoramic imaging.

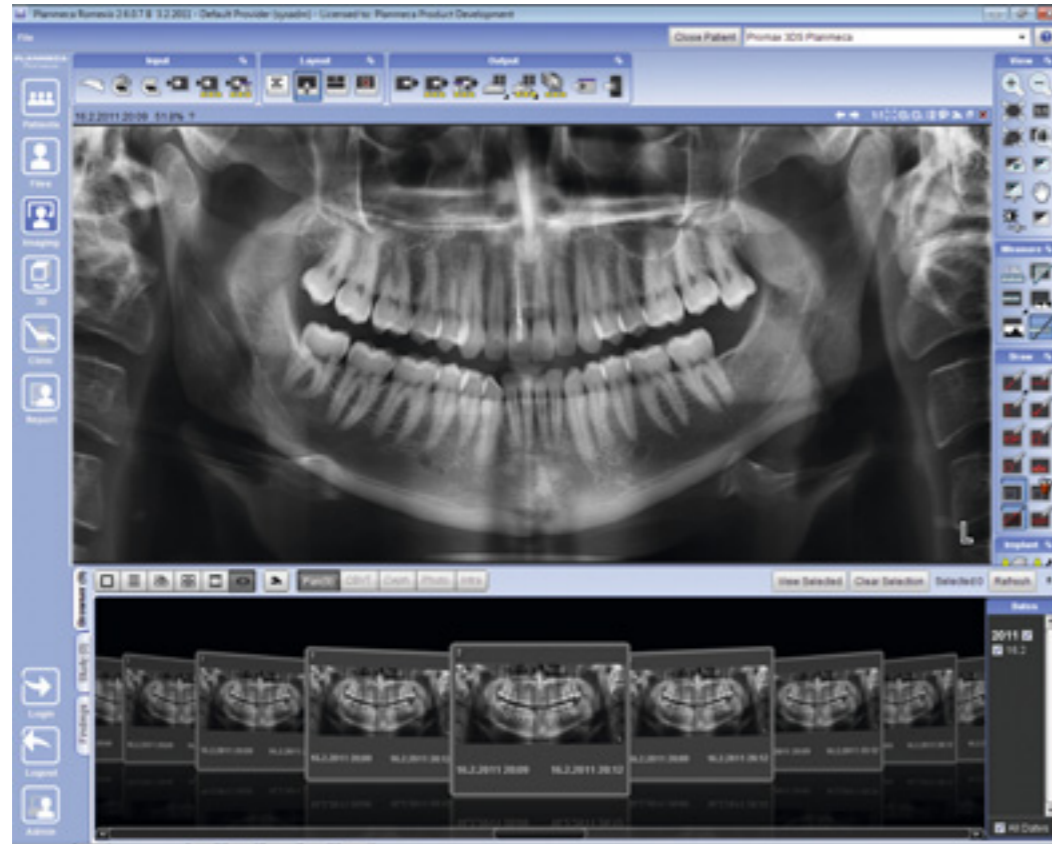

2D SmartPan™ – unique panoramic imaging

- A unique system for 2D imaging
- Uses the same 3D sensor for 2D panoramic imaging, eliminating the need to change sensors
- Users can browse between panoramic images and select the most suitable one for diagnosis
- Same patient positioning and image processing parameters as in 2D imaging programs

2D programs

<i>Standard:</i> Basic panoramic programs	Standard panoramic Lateral TMJ (closed & open) PA TMJ (closed & open) PA sinus
<i>Standard</i>	Child (Paediatric) mode for each standard and optional program to reduce the dose
<i>Optional</i>	Horizontal and vertical segmenting for panoramic program
<i>Optional</i>	True Bitewing
<i>Optional:</i> Advanced panoramic programs	Interproximal panoramic Orthogonal (perio) panoramic Lateral-PA TMJ Lateral multiangle TMJ PA multiangle TMJ PA linear sinus Lateral sinus



Normal SmartPan™ produces 9 different parallel panoramic layers with about 2 mm shift and one autofocus layer



MultiView SmartPan™ calculates 9 different rotated panoramic layers. This allows adjusting the view angle for improved diagnosis.



Extraoral bitewings

What if you could do all your routine diagnostic imaging extraorally?

Planmeca ProMax® extraoral bitewings are ideal for periodontics, elderly and child patients, claustrophobic patients, patients with a strong gag reflex, and patients in pain. Extraoral bitewings enhance clinical efficiency and take less time and effort than conventional intraoral bitewing imaging.



What are the advantages of extraoral bitewings?

- Ideal for all patients – no sensor positioning required
- Consistently opens interproximal contacts, giving better diagnostic value
- Larger diagnostic area than in intraoral modalities
- More clinical data: canine to third molar
- Enhanced clinical efficiency – takes less time and effort than conventional intraoral bitewings
- Enhanced patient experience and comfort – eliminates gagging

Better diagnostic value with extraoral bitewings

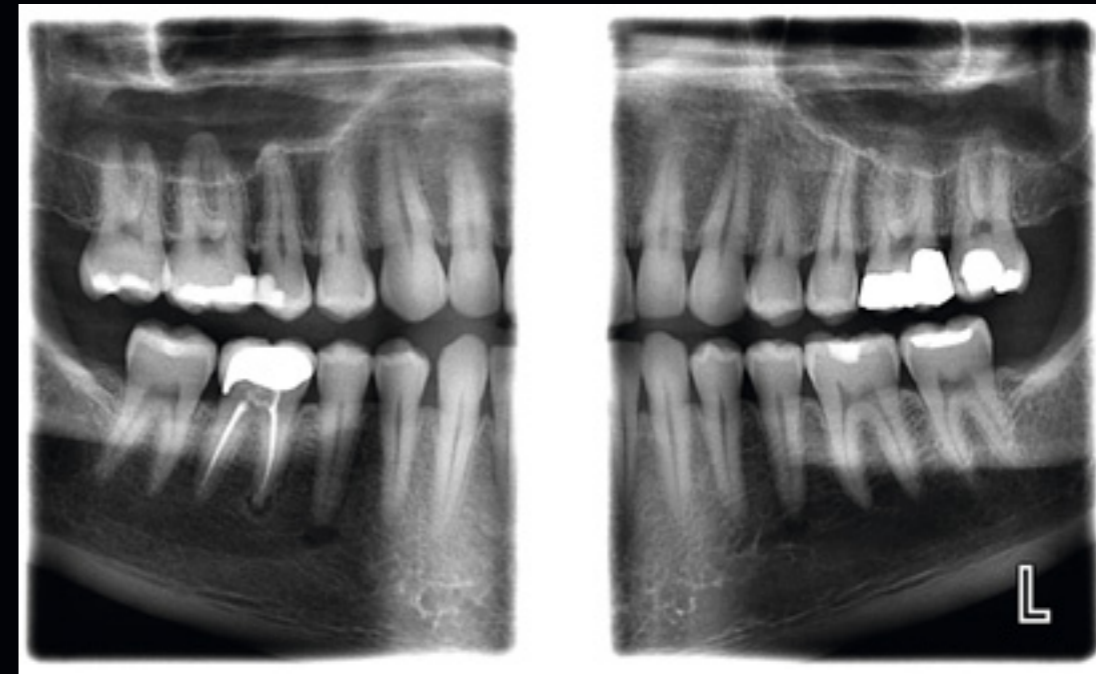

True Bitewing program, adult



Standard panoramic image of the same patient as the bitewing above

True bitewings only possible with our SCARA3 technology

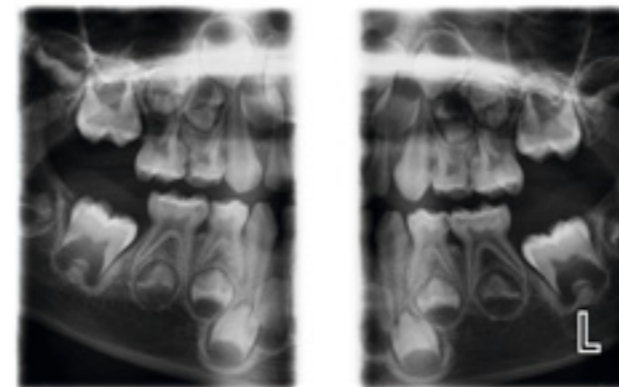

True Bitewing program, 5-year-old child

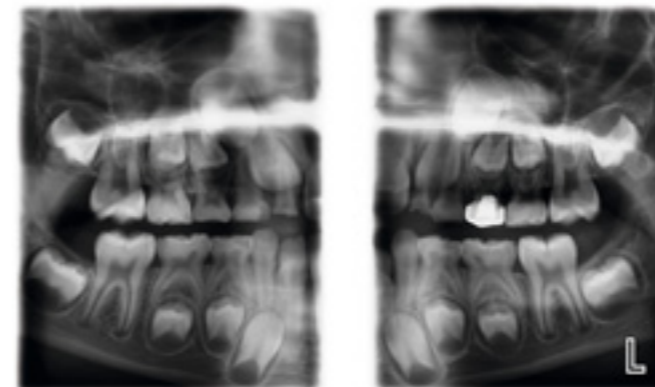

True Bitewing program, 8-year-old child



Quality cephalometry for orthodontics

We offer exceptional equipment and the most advanced software for all your orthodontic needs.



Cephalometric imaging with Planmeca ProMax® units

- The functional and easy-to-use head positioner ensures accurate positioning for all cephalometric projections
- The carbon fibre ear posts and nasal positioner are extremely stable, hygienic, and transparent to radiation
- The unit automatically aligns itself to take cephalometric exposures and then selects a corresponding collimator
- The rotating tube head in the 3D unit eliminates the need to remove the 3D sensor

Easier and more accurate than ever before

Two available options:

One-shot Planmeca ProCeph™ cephalostat

- Effective one-shot cephalostat
- Short exposure time – no motion artefacts, low patient dose
- Image sizes from 18 x 25 cm to 30 x 25 cm

Scanning Planmeca ProMax® cephalostat

- Digital cephalostat that scans your patient's head horizontally using a narrow X-ray beam with an extremely low effective dose of radiation
- Exceptional flexibility in image formats, with field sizes of up to 30 x 27 cm

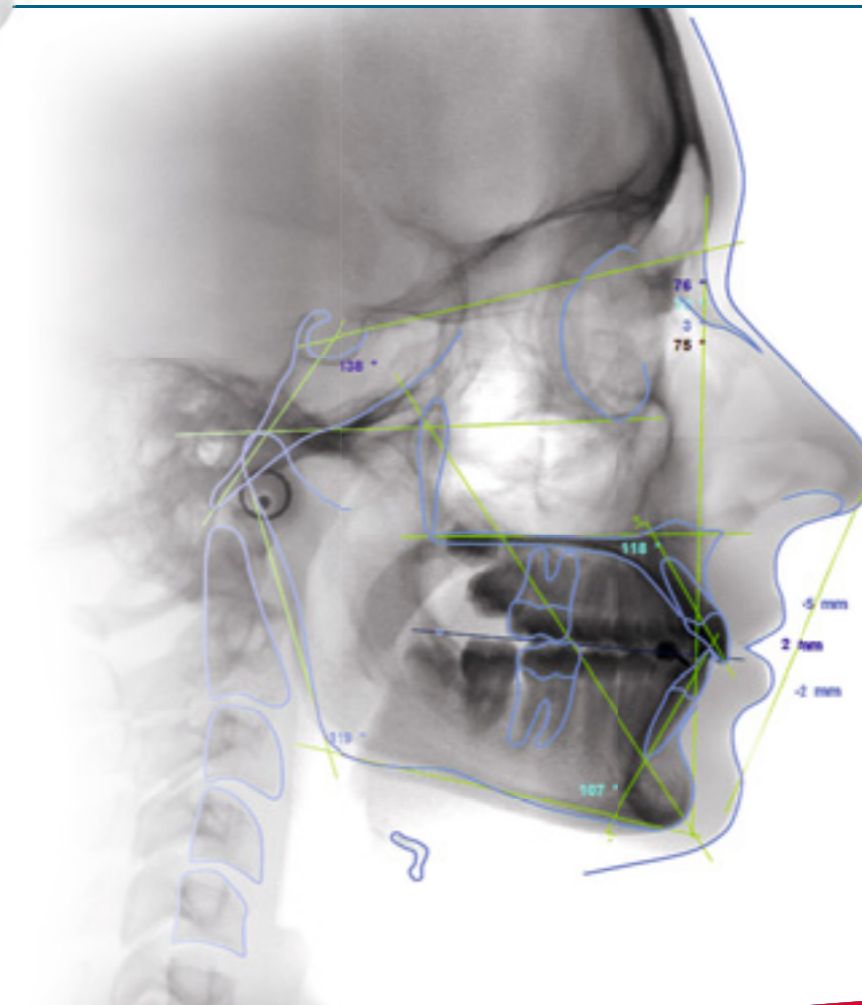

Planmeca Romexis® Cephalometric Analysis module

- Create cephalometric analyses and superimpositions in minutes
- Fully customisable analyses, norms and reports
- Microsoft Excel export and import function
- Compatible with Windows operating system

Planmeca Romexis® one software for all your needs

We offer a revolutionary all-in-one software solution for clinics of all sizes. Our world-leading **Planmeca Romexis®** software is the brains behind all of our products, bringing together all the devices at your dental clinic from CAD/CAM to imaging devices and dental units. It supports the most versatile range of 2D and 3D imaging modalities.



Imaging and CAD/CAM in one software
– an industry first

Reinventing 3D imaging

Our pioneering **Planmeca Romexis®** software offers specially designed tools for implantologists, endodontists, periodontists, prosthodontists, orthodontists, maxillofacial surgeons, and radiologists. You can also view your images wherever you are using our mobile apps, and enjoy unmatched compatibility with other systems.

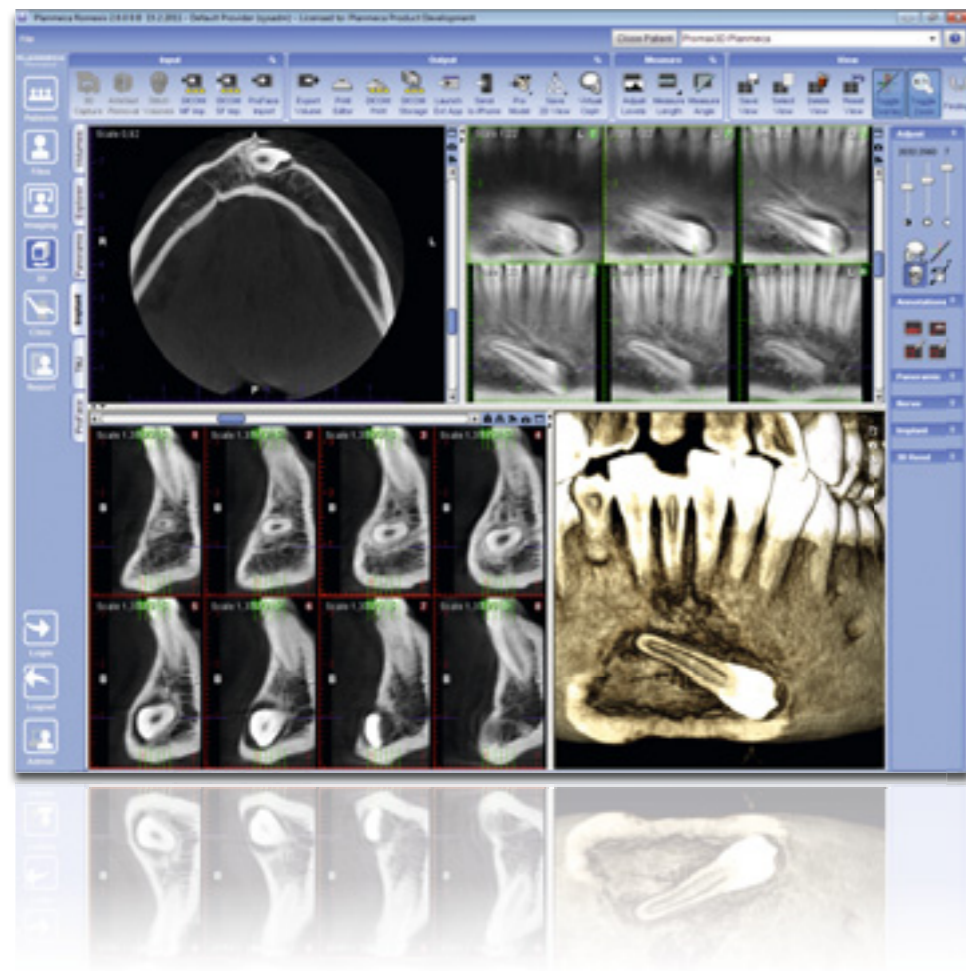

Excellent tools for quality images

With a complete set of tools for image viewing, enhancement, measurement, drawing and annotations, **Planmeca Romexis®** improves the diagnostic value of radiographs. Versatile printing and image import and export functionalities are also included. The software consists of different modules – so you can choose those most suited to your needs.

Free Planmeca Romexis® Viewer application

Full-featured viewer application
No installation required
Mac OS and Windows support
Distribute to specialists or patients

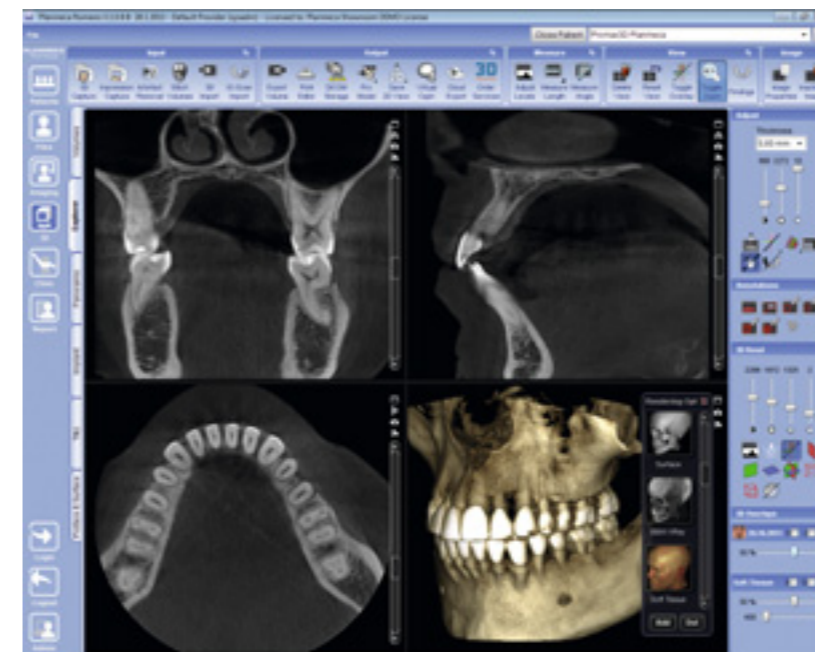

Convenient 3D diagnosis

The Planmeca Romexis 3D rendering view gives an immediate overview of the anatomy and serves as an excellent patient education tool. The images can be instantly viewed from different projections or converted into panoramic images and cross-sectional slices. Measuring and annotation tools – such as nerve canal tracing – assist in safe and accurate treatment planning.

Easy sharing of results

Studies can be quickly converted into multi-page printouts or handed out with the free **Planmeca Romexis® Viewer** media. Cases can be seamlessly transferred to mobile devices or partner clinics that also use Planmeca Romexis.

Best compatibility with other systems

Planmeca Romexis offers excellent compatibility with other systems, allowing you to freely use third-party products at your clinic. TWAIN support and DICOM standard compliance ensure that our flexible software can be used effortlessly with most systems.

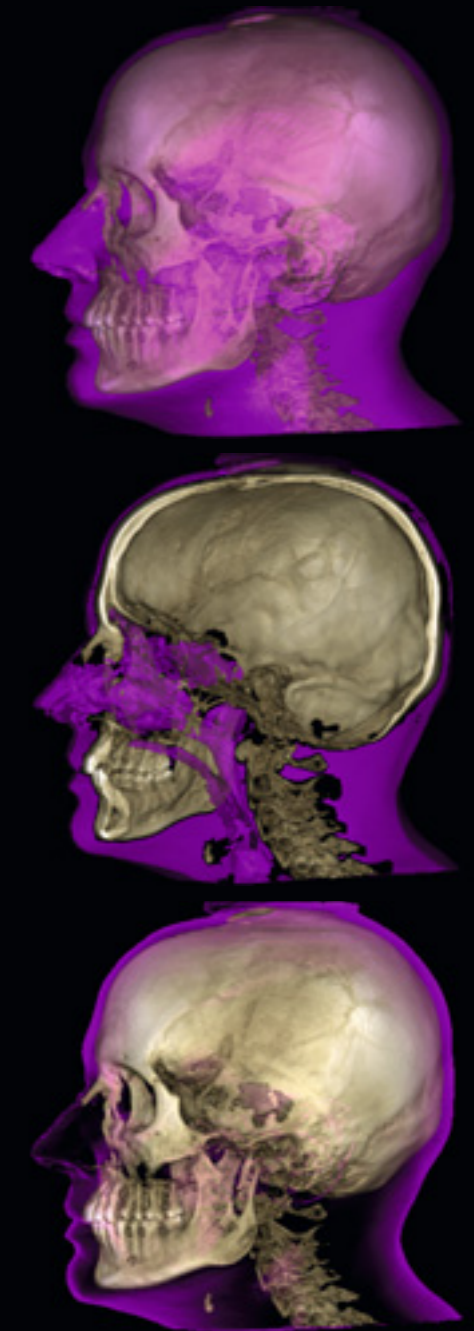

Visualise and measure airways and sinus volumes before and after treatment for simplified diagnosis and treatment planning. Our advanced software tools allow accurate measurements in 3D space. Measurements can easily be reviewed using the saved views.

Implant planning made easy

Our **Planmeca Romexis® 3D Implant Planning** module offers the most sophisticated tools to meet all the needs of modern implantology.

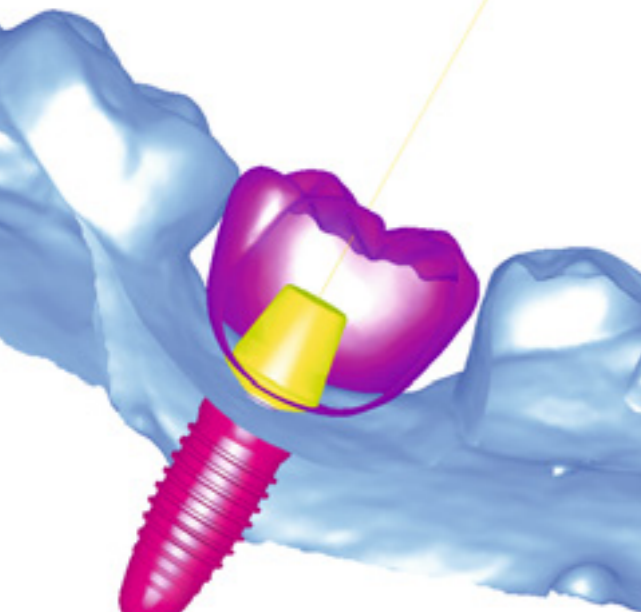
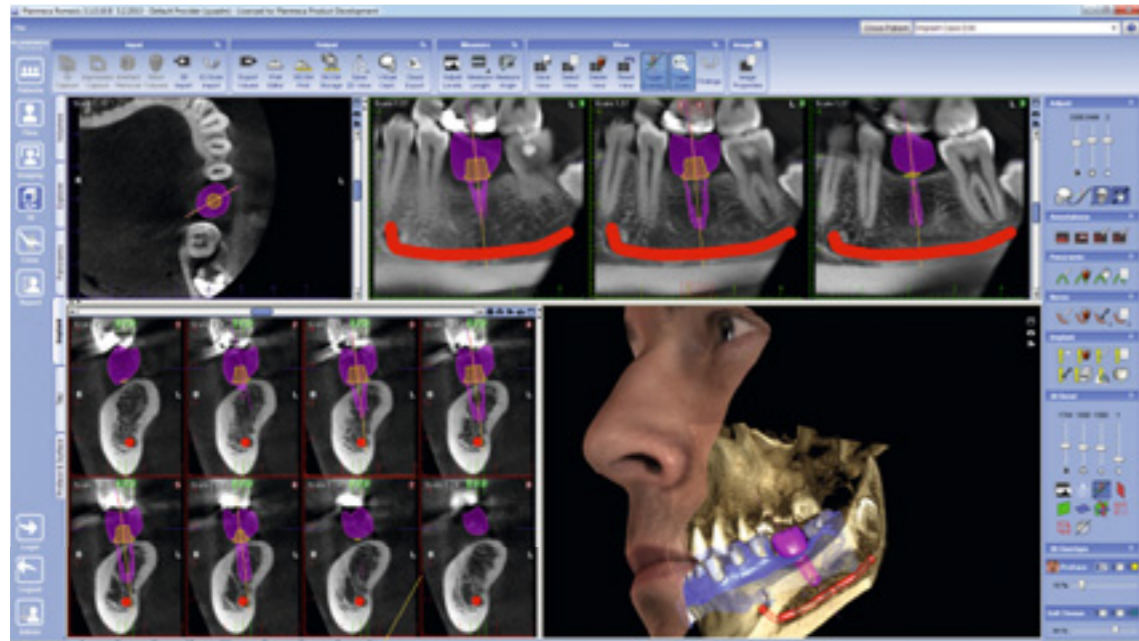

Planmeca Romexis® allows easy planning and verification of implant placement using realistic implant, abutment and crown models from our Planmeca Romexis libraries. You can then import and superimpose a soft-tissue scan and crown design with CBCT data – providing you with the perfect environment for implant planning.



Mark the nerve on the CBCT image

Superimpose the 3D model scan on the CBCT image with Planmeca Romexis® software



Use the Planmeca Romexis® crown library or import patient-specific crown from the CAD system to the software



Use the extensive Planmeca Romexis® implant and abutment library to finalise the plan

Verify the plan with the implant verification tool



Order the surgical drilling guide from Materialise Dental or 3D Diagnostix using the integrated order form

3D tools for orthodontists and dental labs

Planmeca Romexis® 3D Ortho Studio brings innovative tools for orthodontists and dental laboratories. Our advanced module is designed for the examination and analysis of digital dental models scanned with **Planmeca ProMax® 3D X-ray units** or **Planmeca PlanScan®** intraoral scanner – and also for planning orthodontic treatments in 3D.

Dental model analysis

Dental impressions and plaster casts scanned with the **Planmeca ProMax® 3D** model scanning mode can be aligned with the bite index using **Planmeca Romexis®** software. Examination, analysis and treatment planning are then conveniently done in the **Planmeca Romexis® 3D Ortho Studio** module.

The module makes dental model analysis easier than ever by offering all the necessary tools for virtual base creation, occlusion inspection, and versatile teeth and arch measurements.

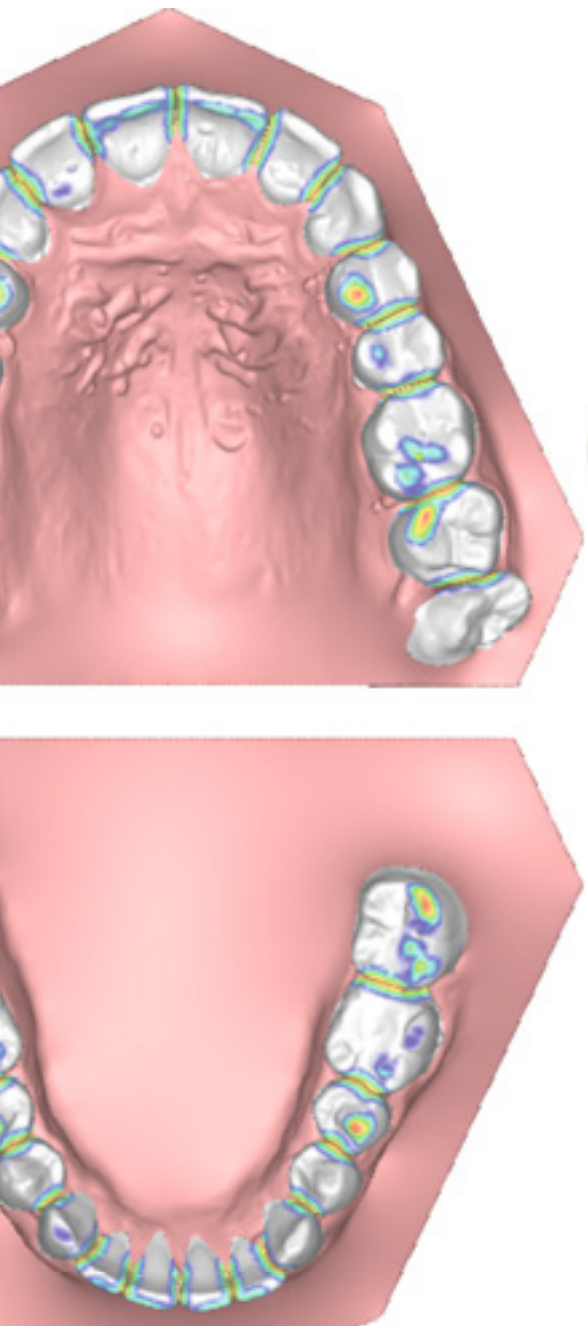

Plaster cast in Planmeca ProMax® 3D



Impression scan in Planmeca ProMax® 3D

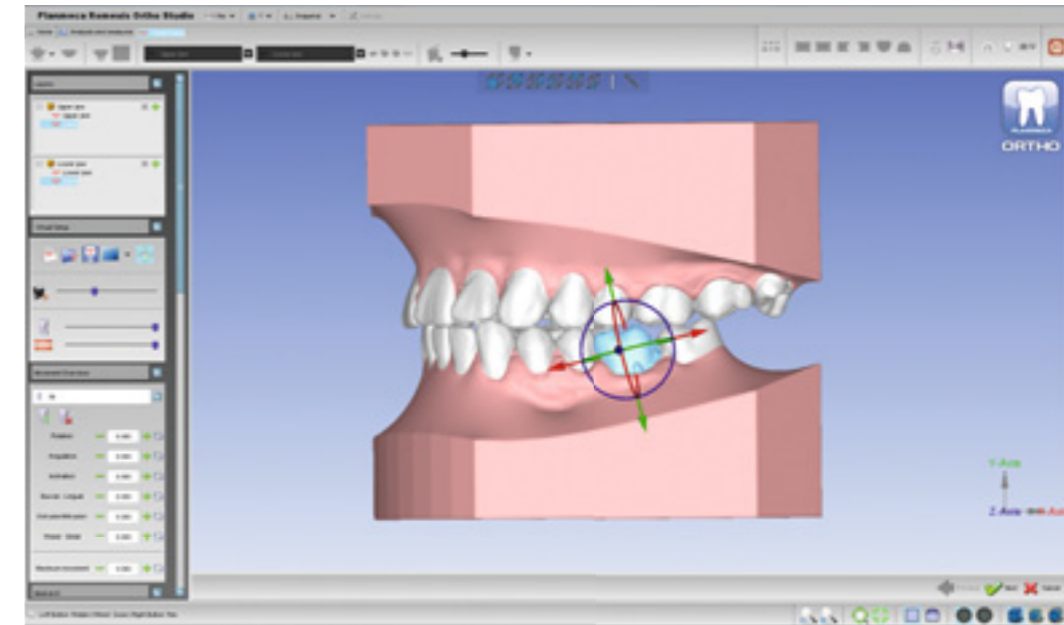

Treatment planning in 3D

A staged treatment plan can be established in Planmeca Romexis 3D Ortho Studio by displacing the teeth in a virtual tooth setup, while visualising intersections and contacts.

All the applied changes such as teeth movements, interproximal reductions and teeth extractions are summarised in a detailed treatment plan report. The treatment plan can be easily shared with others.

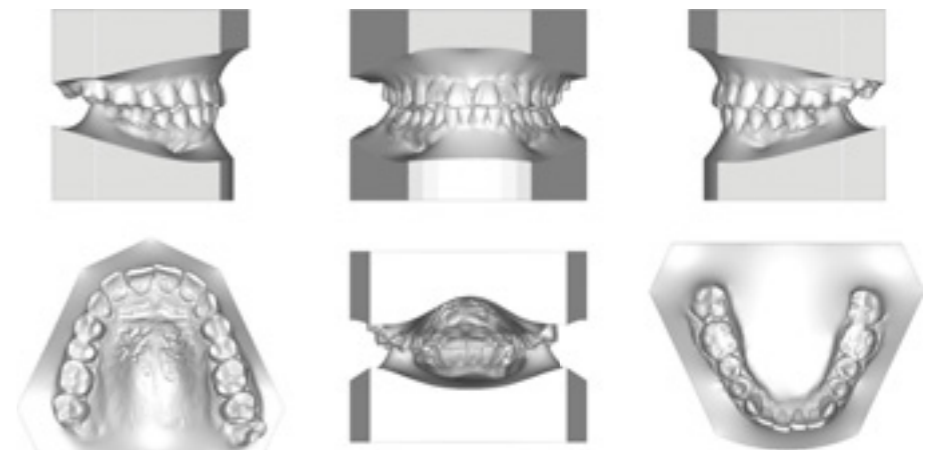

Export of digital dental models in STL format

Planmeca Romexis 3D Ortho Studio generates a sequence of digital dental models for each treatment stage. The models can be exported in STL format for 3D printing and custom appliance design and manufacturing.

The module is compatible with Windows operating system

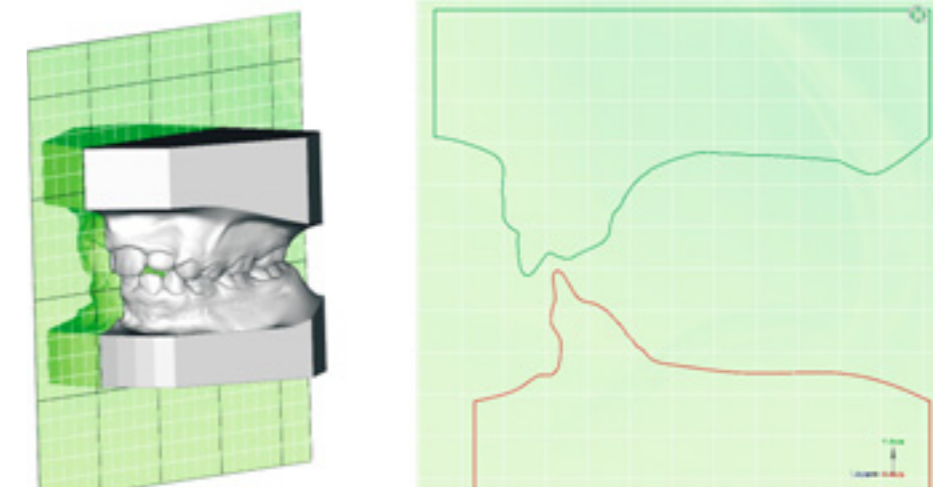

Your mobile world of imaging



Access your images from anywhere in the world with our advanced mobile application. Consult your colleagues and communicate with your patients easily – wherever you are.

Planmeca iRomexis™

Planmeca iRomexis™ is a mobile companion application for the Planmeca Romexis® imaging software. It is specially designed for iPhone and iPad to view 2D and 3D images, 3D models and Planmeca ProFace® images.

View all images taken with your Planmeca X-ray unit and communicate with your patients. Carry images on your mobile device – discuss with other professionals wherever you go. Experience a new level of freedom and co-operation with Planmeca iRomexis.

The application can be downloaded from the App Store free of charge.



Planmeca iRomexis™

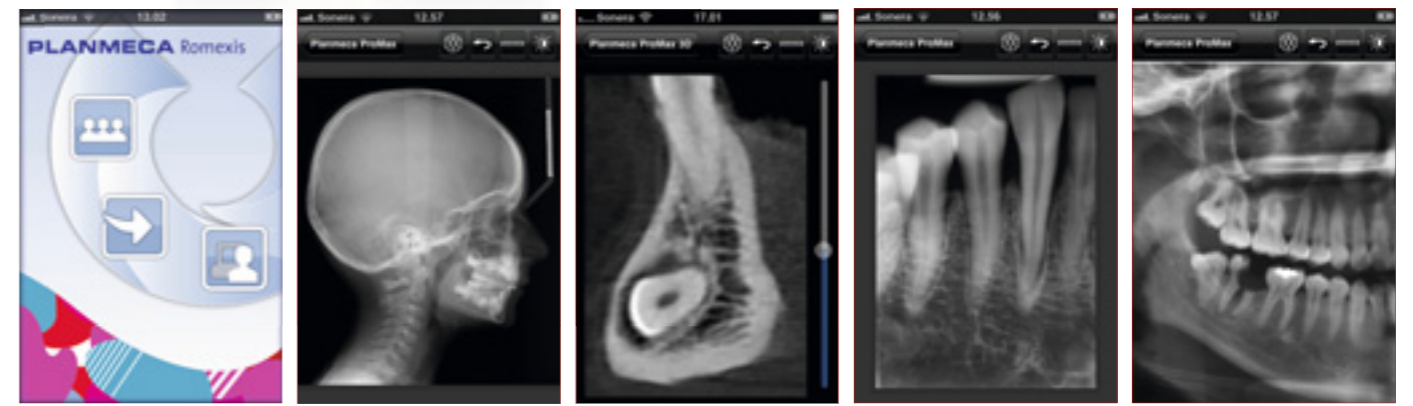

Share images and expertise online

Planmeca Romexis® Cloud is a secure image transfer service for Planmeca Romexis® users and their partners. Now you can easily share images and CAD/CAM cases with any specialist or patient.



Planmeca Romexis® user

- Radiology center
- General practice

Planmeca Romexis® Cloud

**IMAGE
REFERRAL
INTERPRETATION**

Anybody, anywhere

- General practitioner
- Colleague
- Radiologist
- Specialist
- Dental lab
- Patient



Advantages

- Seamlessly integrated into **Planmeca Romexis®** ensuring an efficient workflow – no need for external applications or CDs and DVDs
- Automatic delivery of images and attachments
- Automatic notification to recipient of new cases

- Cases can be sent to any recipient who has an e-mail account
- Secure transfer and storage of information
- Streamline your communication with **Planmeca Romexis® Cloud**

Features

Sending images to recipient

- 2D images: panoramic, cephalometric, photos, intraoral X-ray images
- 3D images: CBCT, 3D photos, surface scans
- All annotations and other elements are included

Sending documents to recipient

- Attach one or more referrals, reports, or other documents

Versatile possibilities for communication

Recipients can download and view images at no cost using:

- Planmeca Romexis
- Free **Planmeca Romexis® Viewer**
- Free **Planmeca iRomexis™** iOS application on iPad and iPhone

Planmeca Romexis® software and Planmeca Romexis® Cloud subscription are required for sending new cases. Visit <http://online.planmeca.com/> to subscribe and start sending images now.

Professionals proudly present the Planmeca ProMax® 3D family



Which one is right for you?

Planmeca ProMax® 3D s

Planmeca ProMax® 3D s is an ideal 3D unit for capturing small details. It is perfect for single implant, endodontic, and wisdom tooth cases.

Planmeca ProMax® 3D Classic

The Planmeca ProMax® 3D Classic imaging sensor covers the whole dentition area, so the unit gives a clear view of the mandible and maxilla.

Planmeca ProMax® 3D Plus

The newest member in our 3D family, Planmeca ProMax® 3D Plus, offers a wide variety of different volume sizes and is a great choice for any imaging need.

Planmeca ProMax® 3D Mid

Thanks to its wide volume size selection, Planmeca ProMax® 3D Mid handles a wide range of diagnostic tasks without compromising best practices.

Planmeca ProMax® 3D Max

Planmeca ProMax® 3D Max is a dedicated 3D imaging device that produces all required volume sizes when diagnosing the maxillofacial region – from the smallest special cases to images of the entire head.

The interviewed have not received any financial compensation or other benefit for the interviews that follow.

Professionals proudly present

Planmeca ProMax® 3D s



Volume sizes

- Ø50 x 80 mm
- Ø50 x 50 mm
- Stitched volume 90 x 60 x 130 mm



Long-term cooperation with Planmeca

"We purchased a **Planmeca ProMax® 3D s** for our dental clinic about four years ago or so. Before that, we had equipped our clinic with five Planmeca dental units, so it was only natural to continue the cooperation with Planmeca also on the X-ray side. Also, several radiologists recommended Planmeca's 3D units to us for their high quality.

We use the unit for implant cases, for lower third molar surgery, and for endodontic cases – particularly in difficult infection cases of teeth with multiple roots. Personally, I use the **Planmeca Romexis® 3D Implant Planning** module the most. It's very practical as I can virtually place the implants myself in the software.

The unit itself is very easy to use – our whole staff uses it, although mainly dentists take 3D images. Positioning is effortless and images are of high quality. And the unit's design is stylish and refined.

I would definitely recommend the unit to others. We have just taken the new sensor into use and I am very satisfied with the image quality. And the feedback from consulting radiologists has been good as well."

*Ari Mäkelä, Licentiate in Dentistry
Dental Care Center Janne, Järvenpää, Finland*



Chinese hospital chose Planmeca ProMax® 3D s

"I bought the **Planmeca ProMax® 3D s** system in September 2010, so I have been using it for over 2 years now. Factors influencing my decision were Planmeca's good reputation and quality-price ratio. For me, it is also important that everyday performance is excellent and if necessary, the after sales service works quickly.

I use my Planmeca 3D s system for various cases – for diagnosis in oral and maxillofacial surgery, for implantology, for diagnosis of periodontal and dental pulp diseases, and for orthodontics. The image quality is very clear, which makes diagnosis very easy with the excellent **Planmeca Romexis®** software.

In implant cases, Planmeca ProMax 3D s is very important for my preparation phase. The data I get from the image of the bone structure and thickness makes the operation easy and safe for the customer.

Planmeca ProMax 3D s really adds value to my work as I can perform many different kinds of tasks quickly and efficiently."

*Sun Zhizong, Dean
Donggang City Stomatology Hospital, Liaoning, China*

Professionals proudly present

Planmeca ProMax® 3D Classic



Volume sizes

- Ø80 x 80 mm
- Ø80 x 50 mm
- Ø50 x 80 mm
- Ø50 x 50 mm
- Stitched volume 140 x 105 x 80 mm

*Dr Pekka Nissinen, GPD &
Dr Kim Lemberg, DDS,
PhD, Specialist in Oral and
Maxillofacial Radiology*

*West Vantaa Dental Clinic,
Finland*



Finnish dental clinic chooses Planmeca ProMax® 3D Classic

"We decided to purchase a **Planmeca ProMax® 3D Classic** 8x8 for our clinic as we wanted to start taking our own CBCT images and not have to send our patients elsewhere to have their 3D X-rays taken. In such cases, there is always the risk that the treatment process will suffer due to the patient's own lack of activity. Now we have our own radiologist and things have gone very smoothly. We also have two surgeons working with us, as we do a lot of implant treatments and treat also difficult endodontic cases."

Implant case acceptance has skyrocketed

"After acquiring the Planmeca ProMax 3D Classic, the amount of implant cases treated at our clinic has increased considerably. Patients are always amazed

when we offer to take their 3D images straight away. The unit is also especially suited to complicated endodontic cases, as you can notice everything in a 3D volume. It is also excellent for cases of wisdom teeth that have grown at a cumbersome angle.

The image quality produced by Planmeca ProMax 3D Classic is excellent. I think it is safe to say that we have the best 3D unit in Finland. This opinion is shared by our surgeons and many radiologists.

The **Planmeca Romexis®** software is a great working tool. It is logical, easy to use, and functions well – just a really good piece of software."

*Pekka Nissinen, GPD,
West Vantaa Dental Clinic, Finland*

Optimal image quality for every single field of dentistry

"I've been using Planmeca ProMax 3D Classic ever since its introduction to the market in 2007, and have used it for all imaging purposes. The image quality has proven to be reliable in every single field of dentistry, even in the most demanding imaging cases. The unit is very user-friendly, and all in all the imaging process can be carried out in an uncomplicated manner.

The Planmeca Romexis software is, in my opinion, the best software on the market when it comes to 3D imaging."

*Kim Lemberg, radiologist, West Vantaa
Dental Clinic, Finland*

Professionals proudly present

Planmeca ProMax® 3D Plus



Volume sizes

- Ø160 x 90 mm
- Ø160 x 50 mm
- Ø90 x 90 mm
- Ø90 x 50 mm
- Ø70 x 70 mm
- Ø70 x 50 mm
- Ø40 x 70 mm
- Ø40 x 50 mm

Dr. Dirk Ladig

*Oral surgery practice,
Hoyerswerda, Germany*



German oral surgery practice is impressed with the image quality of Planmeca ProMax® 3D Plus

"I have been using the **Planmeca ProMax® 3D Plus** unit in my oral surgery practice since 2013. Before that, I had good experience with Planmeca X-ray units. My panoramic X-ray unit ran smoothly for 19 years, the service was good and I was satisfied. Moreover, in 2000, I integrated cone beam computed tomography into my practice by adding a second unit. The decisive factor in purchasing the Planmeca ProMax 3D Plus unit was the radiographs of the new flat-panel devices shown to me by colleagues. The higher resolution of the images was very impressive! There was also a change in the physical layout of my practice. Instead of having two X-ray rooms, I wanted to have one. Planmeca ProMax 3D Plus combines two devices in one: OPG and CBCT. As a result, we need considerably less space.

More information in a single image

I use the device for different kinds of treatment planning; mainly implant cases, but also high-risk wisdom tooth surgery. In my view, a key benefit of the Planmeca ProMax 3D Plus is the possibility of displaying the entire mandible – including the ascending mandibular ramus and mandibular joint – in a single image. I also use the images for diagnosis of foreign body location, apical variances and inflammatory processes in the jaw area. CBCT provides much better diagnostic options for screening for infectious foci in patients with unclear symptoms or certain systemic diseases. Questions related to orthodontic treatments of impacted and displaced teeth, for example, can be easily solved on behalf of colleagues.

Low radiation exposure with adjustable volume sizes

What I really like about the unit is that I can select the volume according to the required image. The radiation exposure for patients is thus kept as low as possible. I use low-dose scans particularly with orthodontic diagnosis. The layer lights are especially useful when centring the image volume.

Operating and adjusting the unit is easy. What's more, the transition from analogue to digital control went well. Since the patients stand upright within the unit, positioning them is much easier than with the predecessor of the CBCT model (with patient bench), without having any problems with motion blur. The new device is also much more pleasant for the patients because there is no feeling of constriction."

*Dr. Dirk Ladig
Oral surgery practice,
Hoyerswerda, Germany*

Professionals proudly present

Planmeca ProMax® 3D Mid



Volume sizes

- Ø200 x 170 mm
- Ø200 x 100 mm
- Ø200 x 60 mm
- Ø100 x 100 mm
- Ø100 x 60 mm
- Ø80 x 80 mm
- Ø80 x 50 mm
- Ø40 x 80 mm
- Ø40 x 50 mm



*Dr Carlo Pizzo, DDS &
Dr Gioia Amico, DDS*

A&P Clinic, Cittadella, Italy



Italian A&P Clinic opts for Planmeca ProMax® 3D Mid after a thorough market analysis

“In our new dental clinic, we have been using **Planmeca ProMax® 3D Mid** for six months now – and we are really satisfied with it.

We chose the unit after a thorough analysis of what the market was offering. We needed an imaging unit that could provide a wide range of FOV choices, the possibility to take panoramic images and cephalometric shots, and last but not least, software that could run natively on Mac OS, because our IT infrastructure was entirely built on Apple computers. The only unit that fulfilled all of these requirements was Planmeca ProMax 3D Mid.”

For every clinical application

“We love using it for taking panoramic images, preliminary treatment planning,

3D scans, wisdom teeth extractions and implant surgery. With **Planmeca Romexis®** – its dedicated software – we can virtually place the exact dental implants we are going to use by choosing them from the integrated 3D implant library. This feature works amazingly well.”

3D magic with the latest technology

“The machine and the software work seamlessly together: they are fast, reliable and easy to use. The 3D rendering is an incredibly powerful tool for us – for visualising the real bone morphology of the patients, and for the patients themselves to understand their clinical situation and the treatment we are offering them. So Planmeca Romexis can

become a really effective communication tool. For this reason, we adopted also the **Planmeca ProFace®** option. By superimposing a 3D scan of the patient's face and a CBCT X-ray image, we can show our clients an easy-to-understand image, in which they can really recognize themselves. Even today, this looks like magic for many of our patients!”

*Dr Carlo Pizzo & Dr Gioia Amico,
A&P Clinic, Cittadella, Italy*

Professionals proudly present

Planmeca ProMax® 3D Max



Volume sizes

- Ø230 x 260 mm
- Ø230 x 160 mm
- Ø130 x 160 mm
- Ø130 x 130 mm
- Ø100 x 130 mm
- Ø130 x 90 mm
- Ø130 x 55 mm
- Ø100 x 90 mm
- Ø100 x 55 mm
- Ø50 x 55 mm

Dr Corrado Gazzero

*MD, Specialist in Radiodiagnostics,
Qualified Expert in Radioprotection*

Studio Gazzero, Genoa, Italy



Radiologist praises the versatility of Planmeca ProMax® 3D Max

"I was the first **Planmeca ProMax® 3D Max** user in Italy and have been using it for about three years now. Before that, I used **Planmeca ProMax® 3D Classic 8x8** for 2 years. And I've been using Planmeca equipment since 1995 because of their image quality, their reliability, and the fast maintenance service.

I really enjoy working with Planmeca ProMax 3D Max. I have used it for every possible dental case, including all aspects of implantology, as well as endodontics, examining alterations of the bone structure, wisdom tooth extractions,

supernumerary teeth and more. In ENT cases, I have used the unit for the study of the paranasal sinuses and facial bone structures.

One of the most remarkable advantages is the possibility to choose the image quality and therefore to optimise the patient dose. The volume selection is complete, the imaging programs are easy to use and patient positioning is effortless."

Dr Gazzero, Studio Gazzero, Genoa, Italy

Patient specific implants

You imagine it. We make it.

Planmeca ProModel™ offers patient-specific implants and physical models for maxillofacial surgery – all individually designed for best possible results.

The implants are designed and manufactured to match any form, ensuring an exact fit to the patient's anatomy. The service also includes physical 3D skull models and surgical guides for assisting in both pre-planning and the surgery itself.

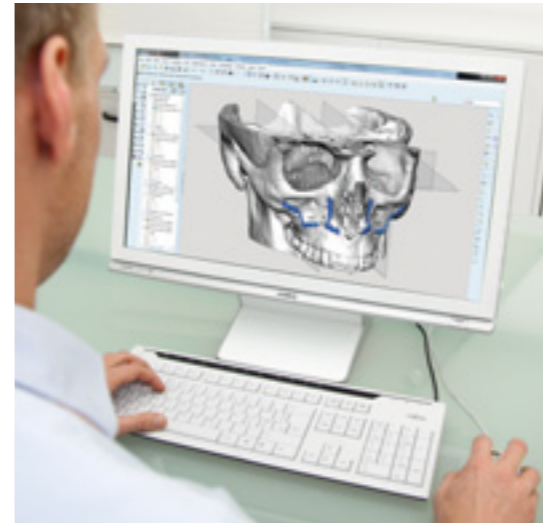

The 3D design is created in an online meeting between surgeon and designer.



Skull model for surgical pre-planning and ready-to-use patient specific implant.

Planmeca ProModel™ service concept

- A unique service for creating patient specific implants, surgical guides and skull models from CBCT/CT images
- 3D implants are designed in an online session between the surgeon and Planmeca designer
- Ordering is quick and easy – from order to delivery in just a few business days
- Reduces operation times by up to 3,5 hours and overall costs by more than 10 %
- Faster and more precise operations leading to better aesthetic results

Faster operations, precise fit and better aesthetic results

Stand out with colour

Complement the splendid design of your **Planmeca ProMax® 3D** X-ray unit by giving it a personal touch with your favourite colours. Select the perfectly matching shades from our exquisite and inspiring collection and create the looks of your dreams!



Technical specifications

Technical data

	3D s	3D Classic	3D Plus	3D Mid	3D Max
Anode voltage	54–90 kV	54–90 kV	54–90 kV	54–90 kV	54–96 kV
Anode current	1–14 mA	1–14 mA	1–14 mA	1–14 mA	1–12 mA
Focal spot	0.5 mm, fixed anode	0.5 mm, fixed anode	0.5 mm, fixed anode	0.5 mm, fixed anode	0.6 mm, fixed anode
Image detector	Flat panel	Flat panel	Flat panel	Flat panel	Flat panel
Image acquisition	Single 200 degree rotation	Single 200 degree rotation	200 / 360 degree rotation	200 / 360 degree rotation	210 / 360 degree rotation
Scan time	7.5–27 s	9–37 s	9–33 s	9–33 s	9–40
Reconstruction time	2–25 s	2–25 s	2–30 s	2–55 s	2–55 s

Comparison

	3D s	3D Classic	3D Plus	3D Mid	3D Max
3D Dental programs	Yes	Yes	Yes	Yes	Yes
3D ENT programs	-	-	Yes	Yes	Yes
ProFace 3D face photo	Yes	Yes	Yes	Yes	Yes
3D Models scan	Yes	Yes	Yes	Yes	Yes
2D panoramic imaging	Yes	Yes	Yes	Yes	Yes
2D cephalometric imaging	Yes	Yes	Yes	Yes	-

Dental programs

Volume size (child mode)

	3D s	3D Classic	3D Plus	3D Mid	3D Max	Voxel size, isotropic
Tooth	Ø50 x 80 mm (Ø42 x 68 mm) Ø50 x 50 mm (Ø42 x 42 mm)	Ø50 x 80 mm (Ø42 x 68 mm) Ø50 x 50 mm (Ø42 x 42 mm)	Ø40 x 50 mm (Ø34 x 42 mm) Ø40 x 70 mm (Ø34 x 60 mm)	Ø40 x 50 mm (Ø34 x 42 mm) Ø40 x 80 mm (Ø34 x 68 mm)	Ø50 x 55 mm (Ø42 x 50 mm)	75 µm*, 100 µm, 150 µm, 200 µm, 400 µm
Teeth		Ø80 x 80 mm (Ø68 x 68 mm) Ø80 x 50 mm (Ø68 x 42 mm)	Ø70 x 50 mm (Ø60 x 42 mm) Ø70 x 70 mm (Ø60 x 60 mm) Ø90 x 50 mm (Ø75 x 42 mm) Ø90 x 90 mm (Ø75 x 75 mm)	Ø80 x 50 mm (Ø68 x 42 mm) Ø80 x 80 mm (Ø68 x 68 mm) Ø100 x 60 mm (Ø85 x 50 mm) Ø100 x 100 mm (Ø85 x 85 mm)	Ø100 x 55 mm (Ø85 x 50 mm) Ø100 x 90 mm (Ø85 x 75 mm)	150 µm, 200 µm, 400 µm
Teeth	triple scan: 90 x 60 x 80 mm	triple scan: 140 x 105 x 80 mm				200 µm, 400 µm
Jaw			Ø160 x 50 mm (Ø160 x 50 mm) Ø160 x 90 mm (Ø160 x 90 mm)	Ø200 x 60 mm (Ø200 x 60 mm) Ø200 x 100 mm (Ø200 x 100 mm)	Ø130 x 55 mm (Ø110 x 50 mm) Ø130 x 90 mm (Ø110 x 75 mm)	200 µm, 400 µm, 600 µm
Face				Ø200 x 170 mm (Ø200 x 170 mm)	Ø100 x 130 mm (Ø85 x 110 mm) Ø130 x 130 mm (Ø110 x 110 mm) Ø130 x 160 mm (Ø110 x 136 mm)	200 µm, 400 µm
Skull					Ø230 x 160 mm Ø230 x 260 mm	400 µm, 600 µm

ENT (Ear, Nose, Throat) programs

Volume size (child mode)

	3D Plus	3D Mid	3D Max	Voxel size, isotropic
Nose	Ø70 x 70 mm (Ø60 x 60 mm)	Ø80 x 80 mm (Ø68 x 68 mm)	Ø100 mm x 90 mm (Ø85 x 75 mm)	200 µm, 400 µm
Sinus	Ø90 x 90 mm (Ø90 x 90 mm) Ø160 x 90 mm (Ø160 x 90 mm)	Ø100 x 100 mm Ø100 x 170 mm Ø200 x 100 mm Ø200 x 170 mm	Ø100 x 90 mm Ø100 x 130 mm Ø130 x 130 mm Ø130 x 160 mm	200 µm, 400 µm, 600 µm
Middle ear	Ø40 x 50 mm (Ø34 x 42 mm) Ø70 x 70 mm (Ø60 x 60 mm)	Ø40 x 50 mm (Ø34 x 42 mm) Ø80 x 80 mm (Ø68 x 68 mm)	Ø50 x 55 mm (Ø42 x 50 mm)	75 µm*, 100 µm, 150 µm, 200 µm
Temporal bone	Ø70 x 70 mm (Ø60 x 60 mm)	Ø80 x 80 mm (Ø68 x 68 mm)	Ø100 x 90 mm (Ø85 x 75 mm)	150 µm, 200 µm
Vertebrae	Ø70 x 70 mm (Ø60 x 60 mm)	Ø80 x 80 mm (Ø68 x 68 mm)	Ø100 x 90 mm (Ø85 x 75 mm) Ø100 x 130 mm (Ø85 x 110 mm)	200 µm, 400 µm
Airways	Ø70 x 70 mm (Ø60 x 60 mm)	Ø80 x 80 mm (Ø68 x 68 mm)	Ø100 x 90 mm (Ø85 x 75 mm) Ø100 x 130 mm (Ø85 x 110 mm) Ø130 x 130 mm (Ø110 x 110 mm) Ø130 x 160 mm (Ø110 x 136 mm)	200 µm, 400 µm

*Requires Endodontic imaging licence, only for the smallest volume

Technical specifications

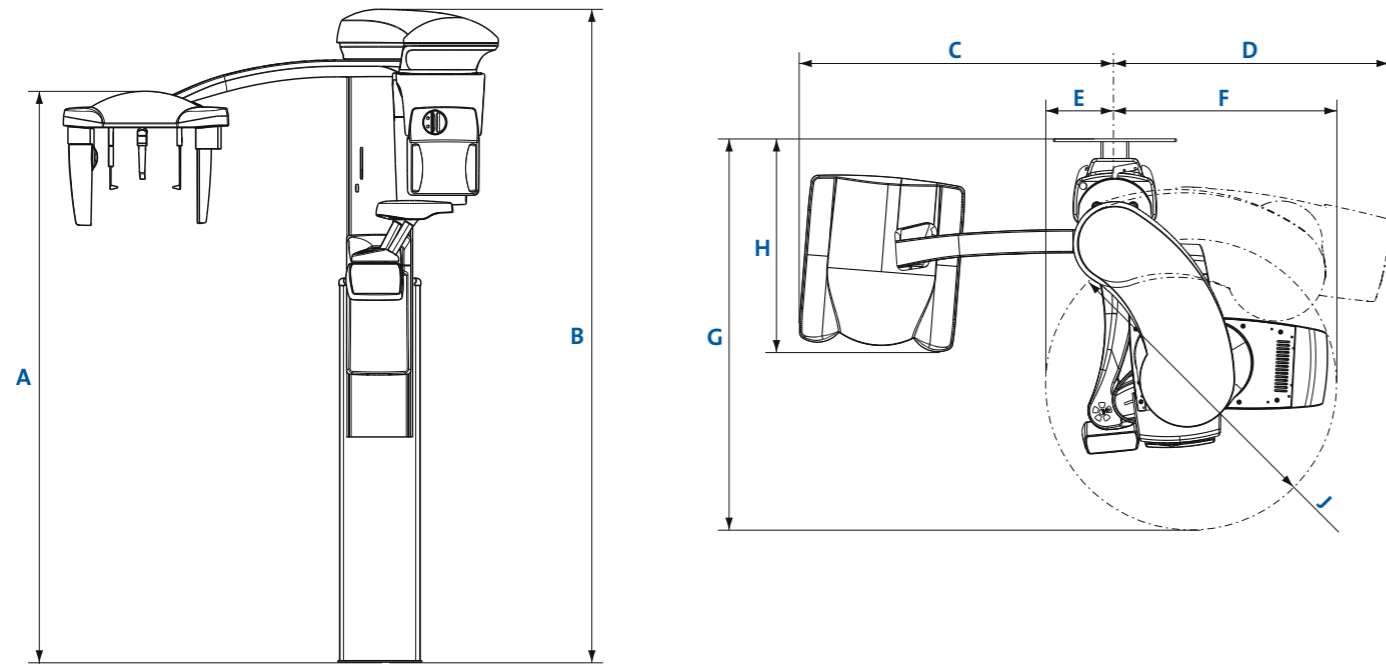

Dimensions

	3D s or 3D Classic	3D Plus or 3D Mid	3D Max
A	1298–2123 mm (51.1–83.5 in.)	1315–2095 mm (51.8–82.5 in.)	-
B	1560–2385 mm (61.4–93.8 in.)	1610–2390 mm (63.4–94.1 in.)	1582–2482 mm (62.3–97.7 in.)
C	1145 mm (45.1 in.)	1130 mm (44.6 in.)	-
D	850 mm (33.5 in.)	930 mm (36.6 in.)	930 mm (36.6 in.)
E	270 mm (10.6 in.)	247 mm (9.7 in.)	222 mm (8.7 in.)
F	698 mm (27.5 in.)	810 mm (32 in.)	788 mm (31 in.)
G	1250 mm (49.2 in.)	1366 mm (53.8 in.)	1351 mm (53.2 in.)
H	777 mm (30.6 in.)	756 mm (29.8 in.)	-
J	Ø820 mm (32.3 in.)	Ø1010 mm (39.8 in.)	Ø1010 mm (39.8 in.)

Physical space requirements

	3D s or 3D Classic	3D s or 3D Classic with cephalostat	3D Plus or 3D Mid	3D Plus or 3D Mid with cephalostat	3D Max
Width	115 cm (44 in.)	200 cm (79 in.)	118 cm (47 in.)	206 cm (82 in.)	116 cm (45.3 in.)
Depth	125 cm (49 in.)	125 cm (49 in.)	137 cm (54 in.)	137 cm (54 in.)	137 cm (54 in.)
Height*	153–243 cm (60–96 in.)	153–243 cm (60–96 in.)	161–239 cm (64–94 in.)	161–239 cm (64–94 in.)	161–239 cm (64–94 in.)
Weight	113 kg (lbs 248)	128 kg (lbs 282)	131 kg (lbs 289)	146 kg (lbs 322)	131 kg (lbs 289)

Minimum operational space requirements

	3D s or 3D Classic	3D s or 3D Classic with cephalostat	3D Plus or 3D Mid	3D Plus or 3D Mid with cephalostat	3D Max
Width	150 cm (59 in.)	215 cm (85 in.)	158 cm (63 in.)	225 cm (89 in.)	158 cm (63 in.)
Depth	163 cm (64 in.)	163 cm (64 in.)	175 cm (69 in.)	175 cm (69 in.)	175 cm (69 in.)
Height*	243 cm (96 in.)	243 cm (96 in.)	239 cm (94 in.)	239 cm (94 in.)	239 cm (94 in.)

*The maximum height of the unit can be adjusted for offices with limited ceiling space.

Example installation

Included in delivery	Planmeca ProMax 3D unit with 3D reconstruction server	
Minimum set up	<p>Client workstation and database server</p> <ul style="list-style-type: none"> Planmeca Romexis 3D Explorer Database server Planmeca Romexis Image Database <p>The client workstation and database server can also be in separate computers.</p>	<p>Ethernet</p>
Additional equipment	<p>Additional diagnostic workstations with different software configurations</p> <p>Planmeca Romexis tools:</p> <ul style="list-style-type: none"> 3D Explorer 3D Cross Sections module 3D TMJ module 3D Implant Planning module DICOM module 	<p>Printer</p>

Planmeca Romexis® imaging software

Supported 2D modalities	<p>Intraoral</p> <p>Panoramic</p> <p>Cephalometric</p> <p>2D linear tomography</p> <p>Photos</p> <p>Stack images (CBCT slices and panoramic slices)</p>
Supported 3D modalities	<p>3D CBCT</p> <p>3D photo</p> <p>3D surface scan</p>
Supported photo sources	<p>Intraoral camera</p> <p>Digital camera or scanner (import or TWAIN capture)</p>
Operating systems	<p>Win XP / Win Vista Pro/ Win 7/ Win 8</p> <p>Win 2003 Server /Win 2008 Server</p> <p>Mac OS X*</p> <p>For detailed information please see system requirements of Planmeca Romexis www.planmeca.com</p> <p>*Cephalometric Analysis module, 3D Ortho Studio module and Planmeca PlanCAD Easy are not supported on Mac OS</p>
Image formats	<p>JPEG or TIFF (2D image)</p> <p>DICOM (2D and 3D image)</p> <p>STL (3D image)</p> <p>TIFF, JPEG, PNG, BMP (import/export)</p>
Image size	<p>2D X-ray image: 1–9 MB</p> <p>3D X-ray image: typically 50 MB–1 GB</p>
Installation options	<p>Client-Server</p> <p>Java Web Start deployment</p>
DICOM 3.0 support	<p>DICOM Import/Export</p> <p>DICOM DIR Media Storage</p> <p>DICOM Print SCU</p> <p>DICOM Storage SCU</p> <p>DICOM Worklist SCU</p> <p>DICOM Query/Retrieve</p> <p>DICOM Storage Commitment</p> <p>DICOM MPPS</p>
Interfaces	<p>TWAIN Client</p> <p>PMBridge (patient information and images)</p> <p>VDDS (patient information and images)</p> <p>InfoCarrier (patient information)</p> <p>Datagate (patient and user information)</p>
3 rd party software integrations	<p>Dolphin Imaging</p> <p>Nobel Clinician</p> <p>Materialise Dental Simplant</p> <p>Straumann coDiagnostiX</p> <p>Cybermed N-Liten</p>

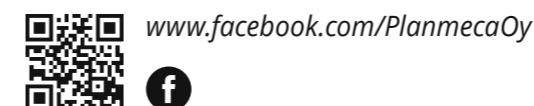

One software for all.



Planmeca Oy designs and manufactures a full line of health care technology equipment, including 3D and 2D imaging devices, CAD/CAM solutions, dental care units and software. Planmeca Oy, the parent company of the Finnish Planmeca Group, is strongly committed to R&D, and is the largest privately held company in the field.

PLANMECA

Asentajankatu 6 | 00880 Helsinki | Finland | tel. +358 20 7795 500 | fax +358 20 7795 555 | sales@planmeca.com | www.planmeca.com

Images may contain optional items not included in standard delivery. Available configurations and features may have country or area specific variations. Some products displayed above may not be available in all countries or areas. Rights for changes reserved.

Planmeca, All in one, Anatomat Plus, Cobra, Comfy, DentreVac, Digital perfection, Economat Plus, Elegant, Flexy, Mini-dent, Perio Fresh, PlanEasyMill, Planmeca AINO, Planmeca ARA, Planmeca CAD/CAM, Planmeca Chair, Planmeca Clarify, Planmeca Compact, Planmeca Intra, Planmeca iRomexis, Planmeca Lumion, Planmeca Maximity, Planmeca Minea, Planmeca Minendo, Planmeca Minetto, Planmeca Noma, Planmeca Online, Planmeca PlanCAD, Planmeca PlanClear, Planmeca PlanMill, Planmeca PlanScan, Planmeca Planosil, Planmeca ProCeph, Planmeca ProFace, Planmeca ProLD, Planmeca ProMax, Planmeca ProModel, Planmeca ProOne, Planmeca ProScanner, Planmeca ProSensor, Planmeca ProX, Planmeca Romexis, Planmeca Serenus, Planmeca SingLED, Planmeca Sovereign, Planmeca Ultra Low Dose, Planmeca Vision, Planmeca Verity, Planmeca Waterline Cleaning System, Planmeca Xtremity, Proline Dental Stool, ProTouch, Saddle Stool, SmartPan, SmartTouch, Trendy and Ultra Relax are registered or non-registered trademarks of Planmeca in various countries.

10032799/12/14/en

